

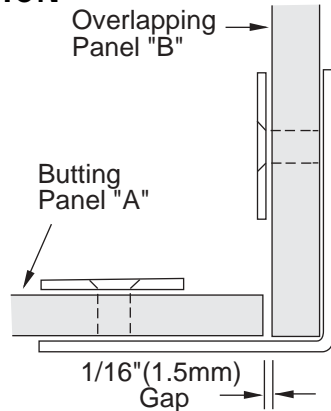

TYPICAL INSTALLATION

Important: Project measurements from the edge of the glass



TEMPLATE OPTION FOR SQUARE CUT GLASS

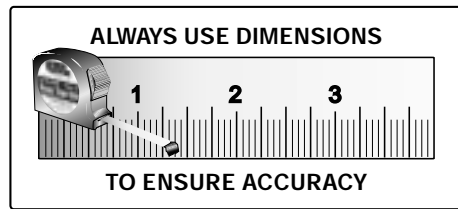
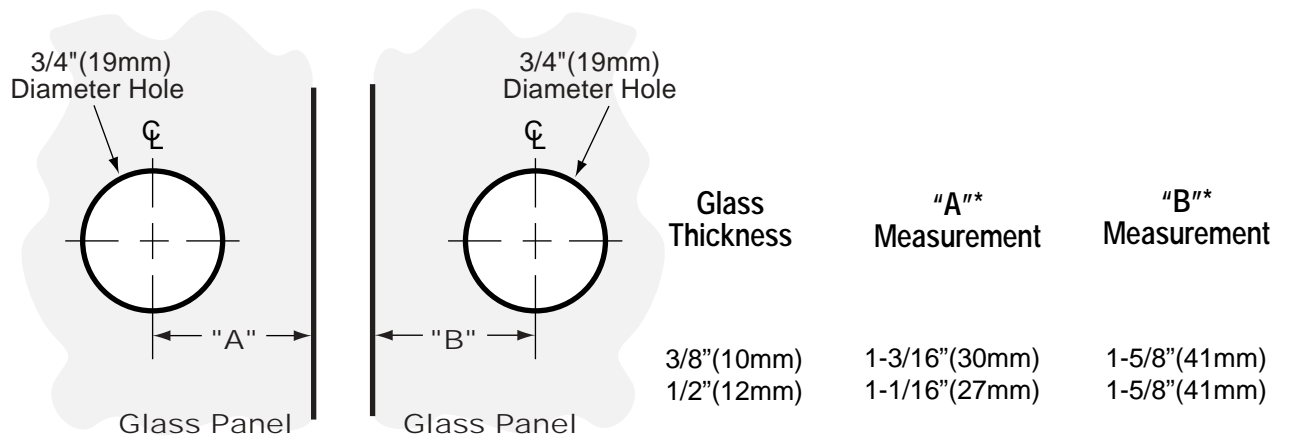

TYPICAL INSTALLATION

Important: Project measurements from the outside of the mitered glass.

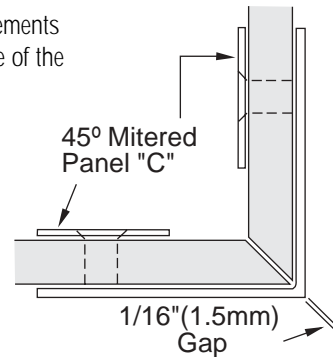

TEMPLATE OPTION FOR 45° MITERED GLASS

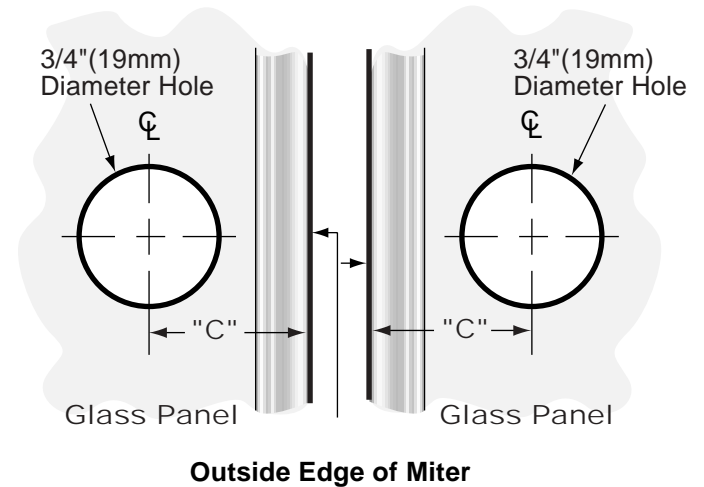

Glass Thickness	"C"* Measurement
3/8" (10mm)	1-9/16" (40mm)
1/2" (12mm)	1-9/16" (40mm)

*From the Outside Edge of Miter

GLASS CLAMPS

The Template Options on This Page Apply to the Following Clamps:
90° Glass Clamp
(Glass-to-Glass Application)

CAT. No. BGC90

90° Glass Clamp

CAT. No. SGC90